



# Flexalen

Connecting energy ambitions

APRIL 2018



# Table of Contents

- 01. WE, THERMAFLEX
- 02. OUR CONTRIBUTION
- 03. MARKETS & APPLICATIONS
- 04. SOLUTIONS
- 05. CERTIFICATES
- 06. MATERIALS
- 07. PERFORMANCE
- 08. SERVICES
- 09. PRODUCTS
- 10. PRE-INSULATED PIPES
- 11. FLEXALEN 600
- 12. FLEXALEN SL
- 13. CUSTOMIZED PREFABRICATION
- 14. CARRIER PIPES
- 15. PROTECTUBE
- 16. MULTI PIPE SYSTEM
- 17. THE FLEXALEN SYSTEM
- 18. TRENCHING
- 19. JOINTING TECHNOLOGY
- 20. TOOLS & ACCESSORIES
- 21. CASE STUDIES
- 22. LET'S CONNECT
- 23. CONTACT



## Minimize the waste of energy, maximize the use of renewables

Societies across the globe are in need of sustainable solutions for energy and water. Together with our stakeholders, we help build systems for future generations. In everything we do, we are inspired by nature. As it is always systemic, smart and efficient in its solutions.

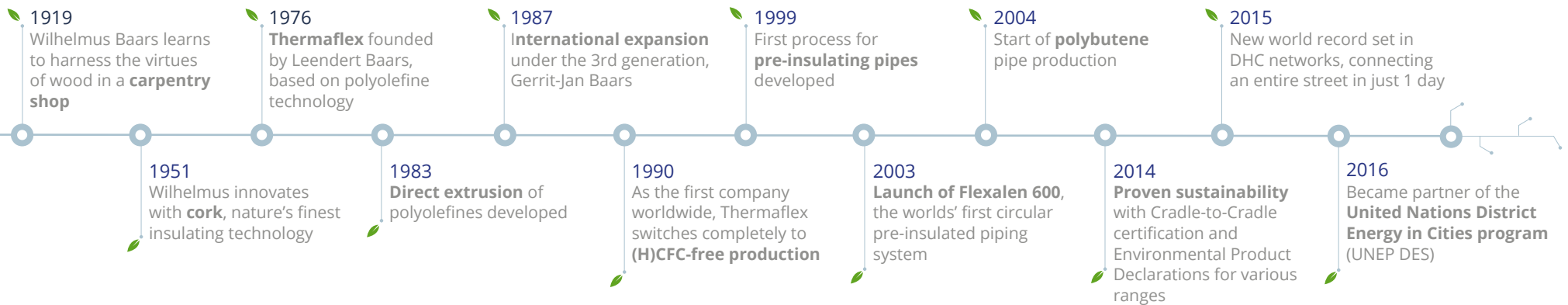



#### ISO 9001:2008

6 regions in the Thermaflex group have achieved ISO 9001 quality management certification for continuous quality improvements in its customer focus, management, and processes.

#### ISO 14001:2004

On top of that, both Thermaflex production locations in Europe have also achieved ISO 14001 certification through effective environmental management systems.



## Our Philosophy

### Taking care of energy and the environment

Energy and water are a necessity in the built environment. They are a basic right for everyone.

We have the knowledge and experience to provide systems to distribute these vital elements efficiently, and smartly. In a manner that is convincingly different and will serve society far into the future.

Today Thermaflex is a source of energy to many people. From the team that is running its every day operations to the business partners and customers with whom we share values and create smart energy saving solutions.



## Our Inspiration

We are inspired by nature in the way that it provides protection without a depletion of resources. Always in full symbiotic harmony with its surroundings, creating a circular state of existence.

Our designs and systems contribute to the circular economy; they are recyclable and serve the transition to renewable energy. Responsible processes demand a minimum of resources for maximum benefit.

At Thermaflex we like to think in solutions rather than in products. Our research and development aims at the specific needs of our customers and end-users. We build close relationships with our stakeholders, creating optimal solutions in cooperation and co-creation with each other.

## Let's join forces to take care of...

### Our resources

The growing scarcity of resources is one of the major challenges in the world today. We believe a solution can be found in the **circular economy**.

Our long term ambition is to reclaim all **materials** and close the loop. This requires a constant drive for improving efficiency, longevity and waste reduction for our systems as well as in our processes.

Our contribution to **water** scarcity and quality lies in delivering leakage-free systems for drinking water and/or sanitation purposes, and reducing and reusing water in our production facilities.



### Our ecosystems

Taking care of our ecosystems, spanning generations, drives us to work together in symbiotic harmony. We aim for maximum benefit for all our stakeholders.

We develop maintenance-free and easy-to-install systems to connect demand for cooling & heating with supply, while lowering energy costs and contributing to green **communities**.

We can only be successful in our mission by working together with like-minded partners throughout the complete **value chain**.

### Our climate

Our major aim is to reduce CO2 emissions by maximizing the use of renewables and minimize the waste of energy.

**Renewable resources** are often locally available, reducing dependency on external suppliers.

We facilitate the use of renewables in our operations wherever possible.

We are continuously improving the **energy performance** of our systems and solutions. In our own organization, in-house programs result in higher energy efficiency and operational excellence.

## Agriculture



Renewable energy in agriculture:  
a natural fit



### Biogas

Cultivating green comfort at home



### Biomass

Efficient biomass for clean, cheap,  
and sustainable energy

## Government & Municipality



Energy and sustainable  
development: an open door



### Schools & Universities

Greater comfort for greater  
learning

## District Heating and Cooling



How to achieve sustainable goals  
in cities



### Eco Quarters

How to become a top-ranking  
Eco City



### Group Heating

Group heating: Better for budgets.  
Better for the environment



### City Heating and Cooling

Green cities: valuable living at  
minimal cost



### Renewable DHC

Renewable energy and DHC:  
the perfect couple

From the agricultural to the residential,  
Thermaflex serves numerous markets...



## Residential



Building (for) the future: smart and sustainable homes



### Single Family Houses

Strike home with efficient convenience



### Apartment Blocks

Sustainable building: a better future for all



### Rural Communities

Think local, heat local



### Attached Houses

Bringing homes and heat together

## Commercial



Future-proofing your business: a sweet deal



### Data Centers

Cool data = Safe data



### Supermarkets

Keep it fresh



### Office Buildings

A comfortable workplace works better



### Shopping malls

Healthy shopping: wallet- friendly, and eco-friendly solutions

... for varied applications

## Cooling

Keep a cool head



## Space Heating

For your comfort



## Potable Water

Water. The basis of life



## Heatpumps

Prime your pump





### Renovation

Closing the gap... and beyond

Everything has an expiry date, that also goes for the systems we put in the ground. Leakages, energy losses, undersized/oversized systems, downtime ... some common ingredients for stinging headaches. So the challenge is to effectively renew that system, as quickly and efficiently as possible, and to make it last. The faster and smoother that process is, the more profitable for all parties involved. That's what drives us!



### Expansion

Sustaining comfort for an expanding world

Expansion is a major challenge for emerging cities around the globe. More than half of the world's population lives in urban areas, and that number is only going to grow. So does our energy consumption, which is expected to rise by more than 55% until 2040. This urges municipalities to evaluate existing heating, cooling and potable water networks as well as to develop new living and working space, and accommodate growing energy needs. It is thus crucial to upgrade and expand infrastructure in an early stage to secure the comfort and security of our future.



### New construction

Breaking valuable new ground

CO<sub>2</sub> neutral energy is now an important goal for both individual buildings and entire cities. Like you, Thermaflex knows that concentrated use of waste heat and renewable energy will help preserve resources and the environment for future generations. One step toward CO<sub>2</sub> neutral energy is the efficient and sustainable distribution of potable water, cooling and heating. This distribution must also be seamlessly provided to assure the comfort and supply security of end-users.



### Street in a day

Future-proof district energy networks

District Energy plays a vital role in moving towards a sustainable future, and clear the way for smart cities with efficient, sustainable and affordable energy systems. The implementation or renovation of such solutions, however, are often considered a major stumbling blocks because of the time, cost, disturbance and operational risk often associated with their installation. But what if we can bury that block? What if we can secure affordable, and future-proof comfort for the residents of an entire street in just a single day?

## Above and beyond industry standards

Choosing Thermaflex solutions ensures that you will comply in every respect with industry standards...



### 3rd party control

Our quality assurance is continuously monitored according to international standards. This transparency assures measurable network quality for every step of the way.



### REACH and VOC compliant

We fully commit ourselves to the protection of human health and environment. All Thermaflex components are risk-free and safe to use under any conditions in conformity with the Registration, Evaluation, Authorisation and Restriction of Chemicals by EU regulation (REACH), the Volatile Organic Compounds list (VOC).



### Potable water & public health certified

Flexalen network has approval from the Water Regulations Advisory Scheme (WRAS) and KIWA-ATA, as suitable for drinking water,



### Environmentally friendly production

Of its own accord, Thermaflex decided to obtain certification of its factory in the Netherlands ISO 14001. Thus, the entire production of pre-insulated Flexalen pipes takes place in a certified workshop. Through these standards, Thermaflex ensures that it protects the environment.

... and even going above and beyond them, giving you a competitive advantage and a means to differentiate



### Cradle to Cradle Certified™ solutions

Our commitment to healthy environments and making scarce resources meet future demands has led us to achieve a 25% Cradle to Cradle Certified™ assortment. For Flexalen, we achieved Cradle to Cradle Certified™ Silver, the world's only in technical pre-insulated pipe systems.



### Economical buildings and ecodistricts

Flexalen systems have frequently been installed for networks supplying ecodistricts and Low Energy Buildings. They comply with the European standards for low energy buildings such as LEED and BREEM. In the case of the renovation of a network in Lacapelle-Marival (46) France, Thermaflex was instrumental in creating savings of up to 30% of energy for the connected district!



### KIWA-ATA International conformity

All our pre-insulated pipe components are KIWA-ATA certified according to EN 15632 for heat-loss and BRL 5609, BRL-K536 for PB pipes.



### Earthquake resistant

Flexalen has been certified as earthquake-proof by the Russian Building Seismic Stability Research Centre for seismic activity up to 7-9 magnitude,

For an overview of our certifications check out our knowledge center:

[www.thermaflex.com/knowledge-center](http://www.thermaflex.com/knowledge-center)

## Quality of raw materials

Our pre-insulated piping consists of:

- A polybutene medium pipe, a highly flexible polyolefine that assures reliable assembly homogeneous welding, quick and easy on-site handling and the best in class for energy efficiency
- Extruded polyolefine insulation enclosing the pipe that, thanks to its hydrophobic and closed cell structure, keeps the water absorption coefficient to a minimum
- A protective HDPE outer casing with UV treatment that ensures efficient mechanical protection throughout the networks' entire lifetime.

## Quality of manufacture

Flexalen systems are manufactured with maximum quality assurance along every step of the way:

- ISO 9001-certified quality management systems for continuous monitoring and improving the quality of our components
- Workshop tests on piping and pre-insulated parts for optimal performance



## Complex networks mastered by weldability

Minimizing risk for maximum performance:

- Risks of leaks minimized by homogeneity of welded materials
- Safe, fully homogenous and easily welded connections ensure lifetime efficiency
- Zero risk of sedimentation with PB and its natural Anti Oxygen Barrier
- Segmentation of the network not necessary, limiting the number of connections needed on site

Corrugated HDPE

Mechanical protection UV Protection

Polyolefine foam

Hydrophobe Insulation

Polybutene pipe

High temperature and pressure resistance



## Prefabrication

Prefabrication on a 100% clean and controlled factory floor, readily tested for performance:

- Minimizes installation risks
- Reduces the amount of on-site welded connections to just 30% of traditional designs
- Allows control of time schedules, handling, installation and overhead costs



# High service pressure reserves to absorb demand fluctuations

Elevated service pressure resistance means that changes in load, through-put or temperature over the network's lifespan can be safely allowed.

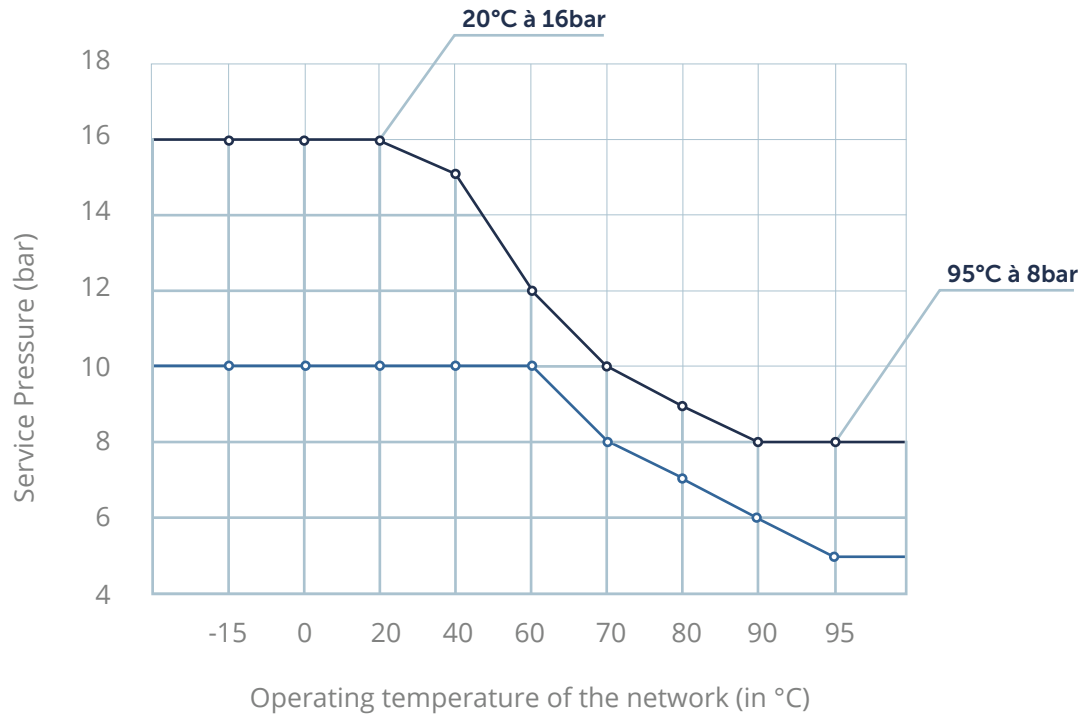

- Up to OD110 20°C/16 bar 95°C/8 bar
- ≥ OD125 20°C/10 bar 95°C/5 bar

## Our Impact

**395,000**

tons CO2 saved in 2016

That's the equivalent absorbed by

**19,750,000** trees



**198,503**

mWh of renewable energy enabled in 2016

which prevents the burning of

**6,320**

truckloads of coal



**8,395**

communities served



## Guiding every step of the way...

### Expert design:

- Expert advice on acceptable flow speed and pressures
- Optimization of diameters (**Figure 01**)
- Structural optimization: hydraulic balancing for optimal pressure drop distribution with the aim to reduce components and costs (**Figure 02**)
- Collaboration with project designers
- Use of FLEXTOOLS and Autocad software
- Static energy loss calculation for complex networks

### Advanced calculation:

Our engineers calculate with Flextools software:

- Suitable diameters for optimal flow speed
- Static energy losses
- Flow and return pressure losses and temperature drop

### Comprehensive training and installation support:

To ensure a smooth installation process, we extend our assistance through:

Trained and certified Flexalen system partners for

- Installation training
- On-site installation support
- Welding training for complex projects
- Installation manuals available for download

Figure 01 - Diameters

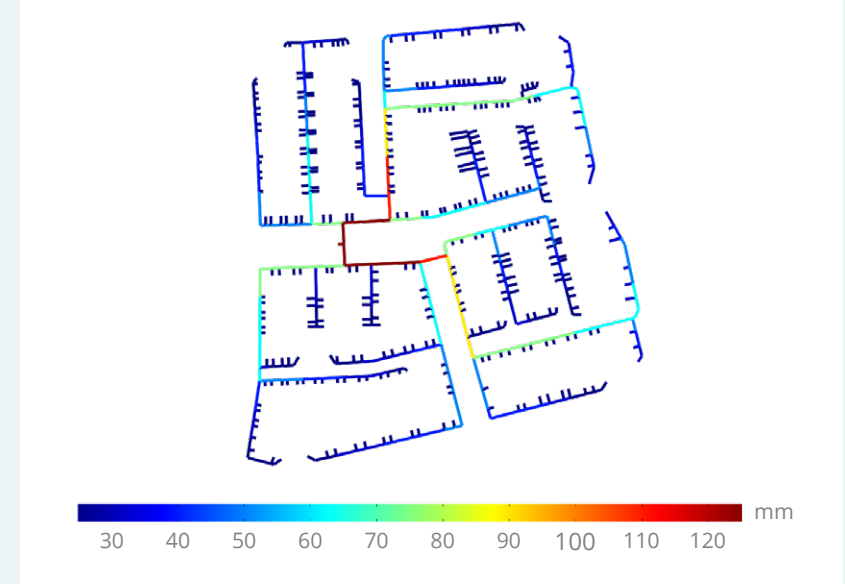
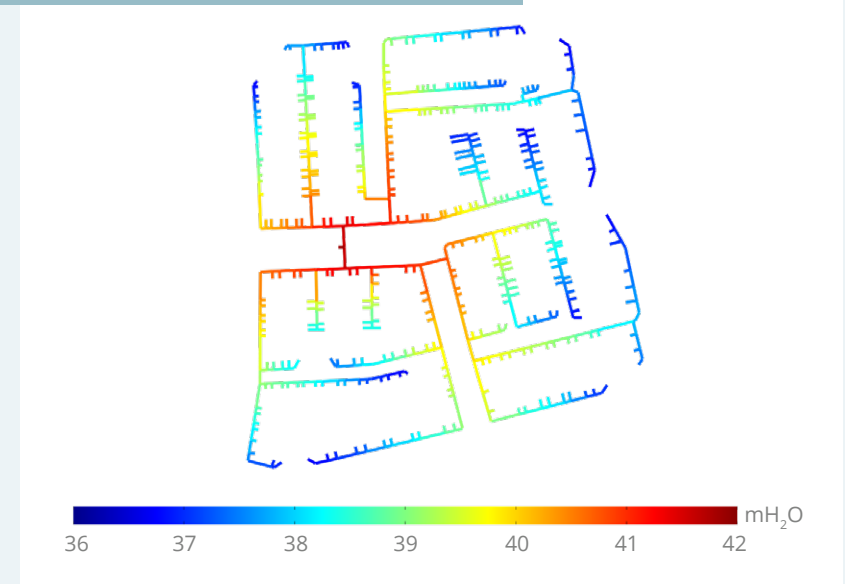



Figure 02 - Pressure distribution



Our Impact

In 2016 Thermaflex connected

**19,150** buildings

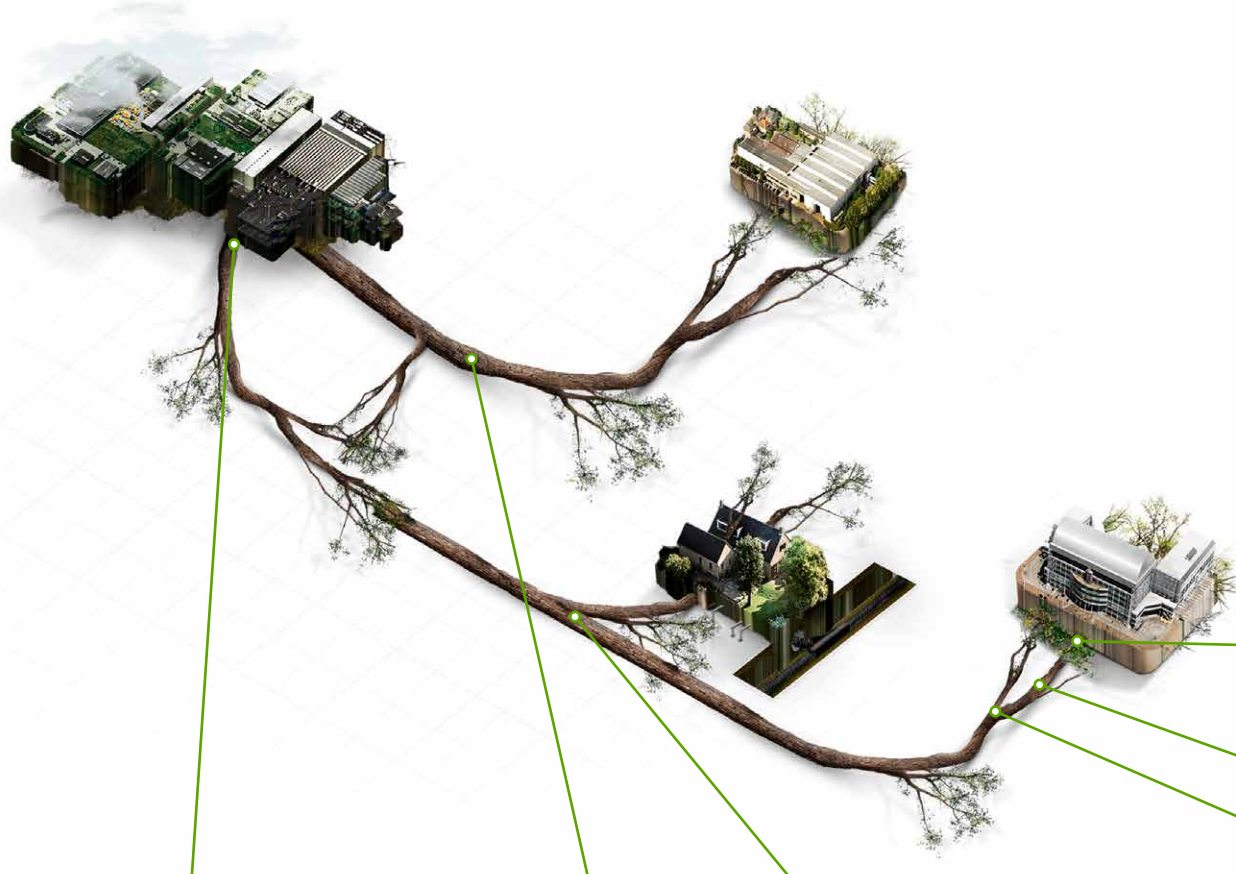

**Jointing Technology**  
Let's connect



**Flexanet**

Securing tomorrow with ready-made district networks



**Pre-insulated Pipes**

Sustainable thermal networks for decades of service



**Flexalink**

Revolutionizing connection technology



**Customized Connections**

Smooth the way



**Protectube**

Flexible durability

## Pre-insulated Pipes

### Sustainable thermal networks for decades of service

You may need thermal energy in multiple locations. Or you realize your current network is not as durable as the building it serves. In either case, it pays to build your thermal network around Thermaflex pre-insulated pipes. We can simplify connection and use of thermal energy in both buildings and district energy. Our solutions are designed to bring you a durable and efficient system adaptable to local circumstances, future needs and changes.



Thermaflex drove innovation further with tailor made solutions integrating:

- Innovative network design
- Speed and quality of installation
- Minimal disturbance to the environment
- Energy efficiency
- Highest standards of safety
- Sustainability to the service of people and the environment
- State of the art logistics

## A sustainable thermal network – environmental capital for years to come

Today's thermal networks are seen as a valuable part of the communities they serve with renewable energy. That's why our smart solutions for thermal energy distribution have become the standard for this important application. We develop and produce state-of-the-art, flexible, pre-insulated pipe systems and pre-fabricated branches to meet both current and future stakeholder needs.

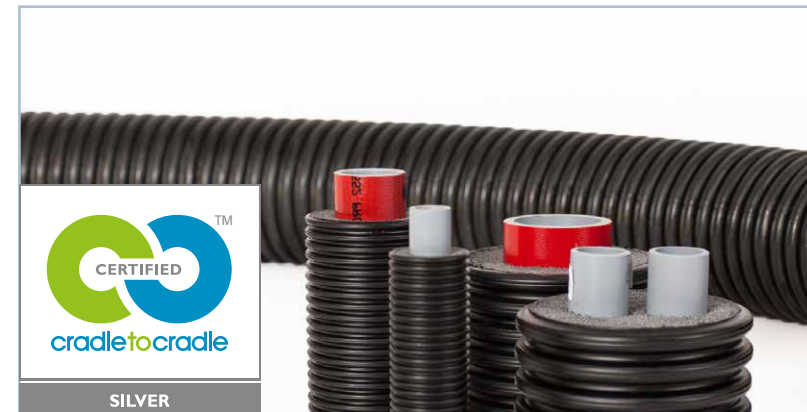



# Flexalen 600

## The flexible solution for timeless efficiency

As the first fully Cradle to Cradle certified™ flexible pre-insulated pipe system worldwide, Flexalen 600 is ideal for group, community and district networks. The efficiency and endurance of its components ensure long-term performance to serve needs of today, and tomorrow.

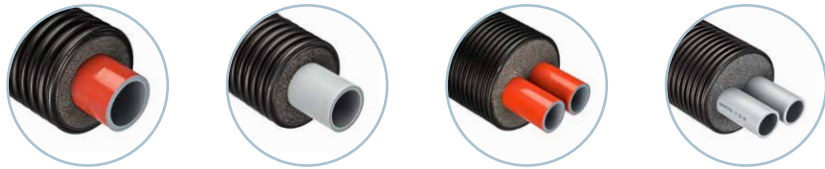

### All-in-one

Flexalen 600 has been developed to offer one solution for heating, cooling and potable water applications, and is ideal for thermal distribution networks. Its high and stable performance in combination with the ease and speed of installation, even in the most difficult conditions, is the reason why... Thanks to the unique properties polybutylene pipes, and the closed cellular structure from the enclosing polyethylene foam, Flexalen 600 is highly pressure, temperature and moisture-resistant. The safe, fully homogenous and easily welded connections further minimize heat losses to ensure a lifetime efficiency of the network.

### For a world to come

We strive to ensure performance on all levels. That also goes for our environment and the generations to come. By minimizing energy losses, we can minimize our waste of energy and subsequently our carbon footprint. With its Cradle-2-Cradle certification, Flexalen 600 is not only a highly efficient, but also the most sustainable choice for thermal energy distribution. On top of that, all its components are environmentally friendly and fully recyclable.

  
Sustainability

- Cradle to Cradle Certified™ Silver
- 100% recyclable
- Environmental Product Declaration (EPD) available

  
Health

- Produced without (H)CFC
- Complies to REACH
- Complies to VOC (Volatile Organic Components)

  
Installation

- Easy quick and safe to weld

  
Service Temperature

- Wide temperature range
- Minimum -15°C
- Maximum 95°C

  
Pressure rating

- up to OD110 20°C/16bar ≥ OD125 20°C/10bar
- up to OD110 70°C/10bar ≥ OD125 70°C/8bar
- up to OD110 95°C/8bar ≥ OD125 95°C/5bar

  
Specifications

- High flexibility
- Usable for both heating and cooling applications
- Potable water certified
- Safe and secure operation
- Long lifetime expectancy

  
Availabilities

- Available in long lengths on coils
- Full range of accessories
- Available with or without oxygen barrier (depending on diameter)
- Available in twin or single carrier pipes
- Several insulation thicknesses available for diverse applications

## F600 Single pipe system

### A flexible choice



Flexalen 600 single line is our most practical solution for heating, cooling and potable water applications. When dealing with space and time restrictions, this flexible, pre-insulated pipe system with a single carrier pipe is the ideal choice for large scale networks, but can also be used for small scale ones.



#### Availabilities

- Pipe diameters medium pipe OD16 – OD125
- Pipes in coils of up to 300m (depending on diameter)

## F600 Plug & Play sets

### The all-in-one solution



The Flexalen 600 turnkey box is our carefree all-in-one package, ideal for small installations. It has all you need to connect as quickly and easily as possible from A to B, while securing a reliable distribution system.



#### Specifications

- Available as a complete set (incl. 4 fittings)
- Individual lengths available (up to 20 meters)
- Easy transport allowed by light weight and compact coil diameters (1.45m sq. boxes)

#### Wide range of applications:

- Air/water heat pumps
- Outdoor
- Swimming pools



#### Availabilities

- Pipe diameters OD20 - OD40
- Pipes in fixed coils of 8, 12, 16 and 20m (other length up to 20 meters on request)

## F600 Double pipe system

### The economical choice



Flexalen 600 double lines have been developed as the most energy-efficient solution for smaller scale thermal water transport. This range is highly suitable for compact networks with low energy demand.



#### Availabilities

- Pipe diameters medium pipe OD16 – OD63
- Pipes in coils of up to 300m (depending on diameter)

## Flexalen Compact

### The take-away package



Flexalen 600 Compact has been developed as a take away solution for heating, cooling and potable water applications. This extension of our Flexalen range offers an assortment of smaller diameters, but with the same distinguished features.



#### Specifications

- Available as a complete set (incl. 4 fittings)
- Individual lengths available
- Easy transport allowed by light weight and compact coil diameters

#### Wide range of applications:

- Air/water heat pumps
- Indoor & Outdoor
- Swimming pools & Garden showers



#### Availabilities

- Available with or without oxygen barrier
- Pipe diameters medium pipe OD16 – OD40
- Pipes in fixed coils of 12,5 and 25m (other length on request)

## 11. FLEXALEN 600

Flexalen 600 single pipe system with one carrier pipe for sanitary and heating applications												
For open system		For closed loop system		DN	Inch	Casing pipe O.D. [mm]	Carrier pipe		Wall thickness [mm]	Minimum bending radius [m]	max. length [m]	Weight [kg/m]
Product code	Product code [NEW]	Product code	Product code [NEW]				O.D. [mm]	I.D. [mm]				
VS-RS40A16	1000-040016-001	x	x	12	½	40	16	11.6	2.2	0.16	500	0.26
VS-RS40A20	1000-040020-001	x	x	15	½	40	20	14.4	2.8	0.20	500	0.28
VS-RS50A25	1000-050025-001	VS-RH50A25	1010-050025-001	20	¾	50	25	20.4	2.3	0.30	500	0.37
VS-RS90A25	1000-090025-001	VS-RH90A25	1010-090025-001	20	¾	90	25	20.4	2.3	0.40	500	0.75
VS-RS63A32	1000-063032-001	VS-RH63A32	1010-063032-001	25	1	63	32	26.0	3.0	0.40	500	0.58
VS-RS90A32	1000-090032-001	VS-RH90A32	1010-090032-001	25	1	63	32	26.0	3.0	0.40	500	0.58
VS-RS125A32	1000-125032-001	VS-RH125A32	1010-125032-001	25	1	125	32	26.0	3.0	0.40	300	1.85
VS-RS75A40	1000-075040-001	VS-RH75A40	1010-075040-001	32	1 ¼	75	40	32.6	3.7	0.50	500	0.86
VS-RS90A40	1000-090040-001	VS-RH90A40	1010-090040-001	32	1 ¼	75	40	32.6	3.7	0.50	500	0.86
VS-RS125A40	1000-125040-001	VS-RH125A40	1010-125040-001	32	1 ¼	125	40	32.6	3.7	0.50	300	1.98
VS-RS90A50	1000-090050-001	VS-RH125A50	1010-160050-001	40	1 ½	125	50	40.8	4.6	0.70	300	2.08
VS-RS160A50	1000-160050-001	VS-RH160A50	1010-160050-001	40	1 ½	160	50	40.8	4.6	0.70	150	2.40
VS-RS125A63	1000-125063-001	VS-RH125A63	1010-125063-001	50	2	125	63	51.4	5.8	0.80	300	2.43
VS-RS160A63	1000-160063-001	VS-RH160A63	1010-160063-001	50	2	160	63	51.4	5.8	0.80	150	2.75
VS-RS125A75	1000-125075-001	VS-RH125A75	1010-125075-001	65	2 ½	125	75	61.4	6.8	0.80	300	2.89
VS-RS160A75	1000-160075-001	VS-RH160A75	1010-160075-001	65	2 ½	160	75	61.4	6.8	0.80	150	2.97
VS-RS160A90	1000-160090-001	VS-RH160A90	1010-160090-001	80	3	160	90	73.6	8.2	1.00	150	3.64
VS-R200A110	1000-200110-001	x	x	100	4	200	110	90.0	10.0	1.25	110	5.40
VS-R200A125*	1000-200125-001*	x	x	100	4	200	125	102.2	11.4	1.50	80	6.38

\*) May differ in various regions

Flexalen 600 double pipe system with two carrier pipes for sanitary and heating applications												
For open system		For closed loop system		DN	Inch	Casing pipe O.D. [mm]	Carrier pipe		Wall thickness [mm]	Minimum bending radius [m]	max. length [m]	Weight [kg/m]
Product code	Product code [NEW]	Product code	Product code [NEW]				O.D. [mm]	I.D. [mm]				
VS-RS63A2/16	1020-063016-001	VS-RH63A2/16	1030-063016-001	2 x 12	2 x ½	63	16	11.6	2.2	0.35	500	0.26
VS-RS75A2/20	1020-063020-001	VS-RH75A2/20	1030-063020-001	2 x 15	2 x ½	75	20	14.4	2.8	0.40	500	0.28
VS-RS125A2/25	1020-125025-001	VS-RH125A2/25	1030-125025-001	2 x 20	2 x ¾	125	25	20.4	2.3	0.60	300	1.80
VS-RS125A2/32	1020-125032-001	VS-RH125A2/32	1030-125032-001	2 x 25	2 x 1	125	32	26.0	3.0	0.60	300	1.90
x	x	VS-RH160A2/32	1030-160032-001	2 x 25	2 x 1	160	32	26.0	3.0	0.60	150	2.14
VS-RS160A2/40	1020-160040-001	VS-RH160A2/40	1030-160040-001	2 x 32	2 x 1 ¼	160	40	32.6	3.7	0.80	150	2.46
VS-RS160A2/50	1020-160050-001	VS-RH160A2/50	1030-160050-001	2 x 40	2 x 1 ½	160	50	40.8	4.6	0.80	150	3.00
VS-RS200A2/63	1020-200060-001	VS-RH200A2/63	1030-200063-001	2 x 50	2 x 2	200	63	51.4	5.8	1.25	125	4.50

# Flexalen SL

## Reduce risk, straighten it out

Our innovative range of pre-insulated pipes secures all-embracing solutions for heating, cooling and potable water applications. In addition to our flexible pipes in coils, Flexalen Straight Lengths is designed to meet large-scale energy needs, and offers a considerable installation and operational advantage.



Flexible

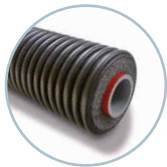

Flexible



Semi-Flexible

## A sustainable choice

Flexalen SL with Polybutylene medium pipes is a highly suitable choice for large-scale thermal energy distribution. Fewer connections reduce leakage risks, ensuring security over time. That, in combination with the energy efficiency and durability of the material, make Flexalen SL an ideal solution. The strength and safety of the welded connections ensure a reliable and care-free system for generations to come.

## Easy does it

Flexalen SL can be combined with all other Flexalen products. And even though it has a straight form, it is semi-flexible and allows for a quick and easy installation in otherwise difficult conditions such as crawlspaces, river crosses or overhead systems. Electro and butt fusion welding techniques offer quick and simple, yet fully homogeneous connections as strong and sustainable as the PB pipes themselves.



### Installation

- Easy quick and safe to weld
- Can be welded outside the trench and pulled into concrete ducts (renovation)



### Service Temperature

- Wide temperature range
- Minimum -15°C
- Maximum 95°C



### Pressure rating

- up to OD110 20°C/16bar    ≥ OD125 20°C/10bar
- up to OD110 70°C/10bar    ≥ OD125 70°C/8bar
- up to OD110 95°C/8bar    ≥ OD125 95°C/5bar



### Specifications

- Semi flexible
- Usable for both heating and cooling applications
- Full range of accessories
- Safe and secure operation
- Long lifetime expectancy



### Availabilities

- Available with single carrier pipe
- Pipes in straight length of 6/12m
- Pipe diameters medium pipe OD63 – OD125 (flexible)
- Pipe diameters medium pipe OD160 – OD225 (semi flexible)



## 12. FLEXALEN SL

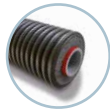
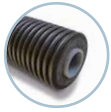

Straight Lengths - Flexible												
Product code	Product code [NEW]	Product code	Product code [NEW]	DN	Inch	Casing pipe O.D. [mm]	Carrier pipe		Wall thickness [mm]	Minimum bending radius [m]	max. length [m]	Weight [kg/m]
							O.D. [mm]	I.D. [mm]				
F-SL160A63/6	1001-125063-015	F-SL160A63/6	1011-125063-015	50	2	160	63	51.4	5.8	0.80	6	2.75
F-SL160A75/6	1001-160075-015	F-SL160A75/6	1011-160075-015	65	2½	160	95	61.4	6.8	0.80	6	3.05
F-SL160A90/6	1001-160090-015	F-SL160A90/6	1011-160090-015	80	3	160	90	73.6	8.2	1.00	6	3.60
F-SL200A110/6	1001-200110-015	F-SL200A110/6	1011-200110-015	100	4	200	110	90.0	10.0	1.25	6	5.40
F-SL200A125/6	1001-200125-015	F-SL200A125/6	1011-200125-015	100	4	200	125	102.2	11.4	1.50	6	6.50



Straight Lengths - Semi flexible											
Product code	Product code [NEW]	DN	Inch	Casing pipe O.D. [mm]	Carrier pipe		Wall thickness [mm]	Minimum bending radius [m]	max. length [m]	Weight [kg/m]	
					O.D. [mm]	I.D. [mm]					
FV-R250A160/12	1920-250160-030	150	6	250	160	130.8	14.6	20	11.80	11.7	
FV-R315A225/5,8	1920-315225-010	200	8	315	225	184.0	20.5	26	5.80	22	
FV-R315A225/12	1920-315225-030	150	6	250	160	130.8	14.6	20	11.80	11.7	

## Flexanet

### Connections just got more reliable

Imagine the most challenging parts of the network installations - branches and connections - can be taken out of the field - with all related unpredictable external influences. The joints are made to order on our 100% clean and controlled factory floor. Leakages, poor post insulation, corrosion,... this vocabulary all belongs to the past.

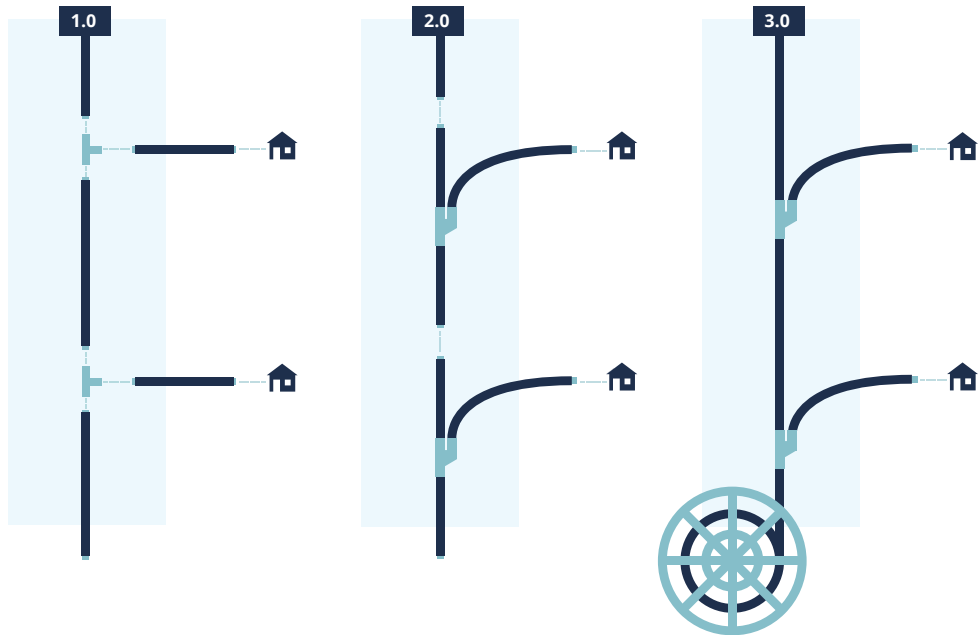

1.0

## Prefabricated Connections

### Smooth the way

Our range of standard prefabricated connections includes all your standard Tees, Bends and Elbows as well as custom components that may be needed to deal with specific connections. We can provide these components in any size to suit all specific wishes, circumstances and challenges.



2.0

## Flexalink

### Revolutionizing connection technology

Imagine the most challenging part of network installations – branches and connections – would actually become a cakewalk. Imagine they could be taken out of the field (with all its unpredictable external strains), carefully prepared on a 100% clean and controlled factory floor, readily tested for performance, and reduce the amount of welded connections needed on-site by 75%. Flexalink makes it happen.



3.0

## Flexanet

### Ready-made district networks on coil

FlexaNet is our strikingly efficient, high-speed solution for district heating and cooling networks. A fully pre-fabricated Flexalen network can realize all-round, ready-made solutions that can be swiftly rolled out to secure the energy needs of today, and of future generations. Its proven track-record to connect an entire street in just a single day, makes it a world record leader in district energy networks.

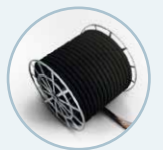

# Prefabricated Connections

... the best preparation

**RATING:**

EASE & SPEED

RELIABILITY

TOTAL COST OF OWNERSHIP SAVINGS

**1.0**

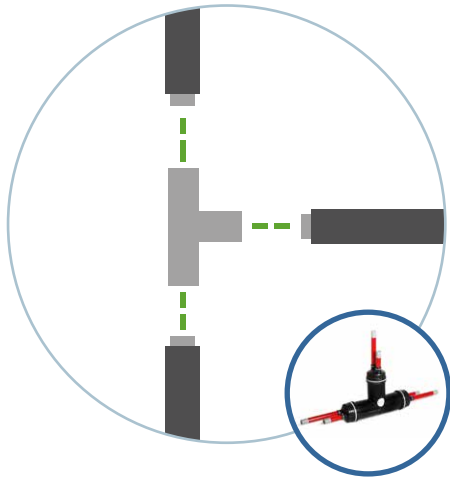

Availabilities

- Standard diameters: Ø16 to Ø225
- Available with oxygen barrier: ≤ Ø25 to Ø90

**Prefabricated components:**

- Standard: Bends, Elbows, Corners (45° or 90° degrees)
- Custom components (e.g. headers, Y-pieces, ...)

**2.0**

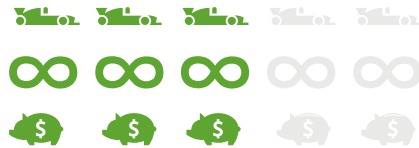
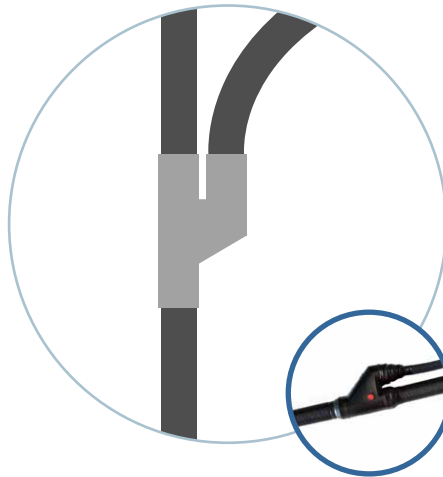

Availabilities

- Main pipe diameter: Ø25 to Ø110
- House connection Ø25 to Ø40 (Double lines on request)
- Customization is standard

**3.0**

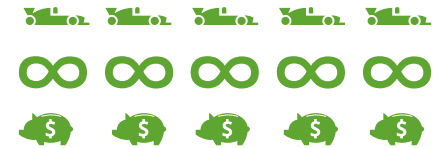

Availabilities

- PB pipe diameter main line: Ø25 to Ø75,
- Outer casing diameter house connection: Ø90 (PB25 to PB40)
- Customization is standard

# Flexalink

## Revolutionizing connection technology

Imagine the most challenging part of network installations – the branches and connections – could be taken out of the field, carefully prepared on a 100% clean and controlled factory floor, readily tested for performance, and immensely reduce the amount of welded connections needed on-site. Imagine.



## Changing the game

Implementing or replacing district energy networks can put quite some strain on communities, considering the endless road blocks, parking problems, and disturbing excavation works that come with it. On top of that, installation can be risky; leakages, deteriorating insulation, downtime, ... usually a direct cause of faulty connections. This leads to underperforming networks, higher energy bills, and escalating operating costs. But what if we could change the game, and overcome those barriers?

## Breaking the barriers

Co-created in 2010 with several DH companies, Flexalink has proved to be this game-changer. Ideal for both heating, cooling and tap water grids, our fully prefabricated house connections reduce on-site connections to just 30% of traditional designs. Instead of months, the installation of district energy networks become a matter of days, allowing effective control of costly labor and time schedules, preventing any contract variations.



### Installation

- 75% reducing installation time on site



### Water

- 100% watertight



### Specifications

- Risk free: pressure tested in our factory
- No build up of scale or calcification
- Very low resistance/pressure drop due to smooth interior walls



### Service Temperature

- Wide temperature range
- Minimum -15°C
- Maximum 95°C



### Availabilities

#### Standard lengths

- 1m +5m backbone Flexalen SL
- 5m house connection Flexalen 600
- Customization on request

#### Diameters

- Main pipe OD25 - OD110
- House connection OD25 - OD40

### 13. CUSTOMIZED PREFABRICATION

Double lines on request  
[nederland@thermaflex.com](mailto:nederland@thermaflex.com)



Flexalink - Single pipe system							
Main pipe O.D. [mm]	House connection pipe O.D. [mm]				length A [m]	length B [m]	length C [m]
	20	25	32	40			
25	o	o	-	-	1	5	5
32	o	o	o	-	1	5	5
40	o	x	x	o	1	5	5
50	o	x	x	x	1	5	5
63	o	x	x	x	1	5	5
75	o	x	x	x	1	5	5
90	o	x	x	x	1	5	5
110	o	x	x	x	1	5	5

o = option x = standard - = at time of publication not available  
 Customization (other lengths) on request

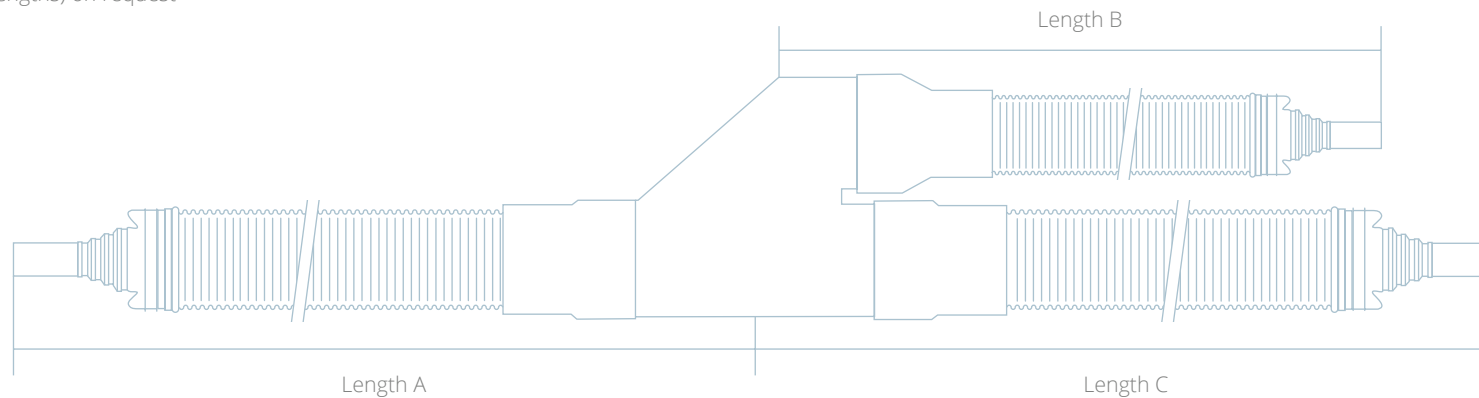



# Carrier Pipes

## Expect 100 years of reliable service

Stakeholders such as utility companies, municipalities and building owners tell us they need a reliable, durable and maintenance-free system up to 100 year life expectancy and excellent flow properties. On top of that want it to be sustainable, too. Our carrier pipes are designed and built to meet those expectations.

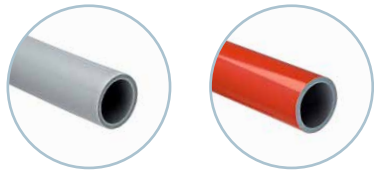

## PB-1: The best solution for the best carrier pipes

We have worked closely with several leading energy companies to find the best possible material for the carrier pipes in our thermal network solutions. Their choice, and ours, is Polybutene-1 (PB-1). Polybutene-1 piping systems deliver long-life performance in severe industrial, large-scale and domestic applications. PB-1 can withstand up to 100 years of temperatures below 70°C and allows multiple connection techniques that include homogeneous welded joints and provides excellent recyclability. PB-1 also has broad acceptance among engineers, architects, planners, building contractors, installers and homeowners. Its easy and reliable assembly, pipe flexibility, on-site handling and best in class energy efficiency all make it the right material for the job. When you specify Thermaflex PB-1 carrier pipe you can expect long-term, durable performance.

 Sustainability

- Fully sustainable

 Installation

- Ease and speed of installation

 Specifications

- Pipe flexibility – low bending forces
- Energy savings in use
- No scale build up or corrosion
- Quiet systems
- Low possibility of cold weather burst
- Safe and secure operation
- Long lifetime expectancy
- Low thermal expansion + forces

 Service Temperature

- Wide temperature range
- Minimum -15°C
- Maximum 95°C

 Pressure rating

- up to OD110 20°C/16bar    ≥ OD125 20°C/10bar
- up to OD110 70°C/10bar    ≥ OD125 70°C/8bar
- up to OD110 95°C/8bar    ≥ OD125 95°C/5bar

 Flexibility

- Excellent flexibility
- Reduces the need of fittings
- Bending radius: 8x pipe diameter

## PB-1 without oxygen barrier

### For open and closed circular systems

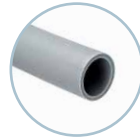

Polybutene has an unrivalled balance of properties to satisfy the demands of hot, cold and potable water distribution. Its flexibility and superior resistance to stress, corrosion, frost and aggressive water, in combination with its performance and environmental success make it the ideal choice.



#### Availabilities

##### Coils:

- Pipe diameters medium pipe OD16 – OD75
- Coils of 102m (other lengths on request)

##### Sticks:

- Pipe diameters medium pipe OD16 – OD225
- Sticks of 5,8 /12m (depending on diameter)

Flexalen PB-1 pipes without oxygen barrier				
Product code	Product code [NEW]	max. m	DN	Inch
PB-25A/102M	1302-025000-015	102	20	¾
PB-32A/102M	1302-032000-015	102	25	1
PB-40A/102M	1302-040000-015	102	32	1¼
PB-50A/102M	1302-050000-015	102	40	1½
PB-63A/102M	1302-063000-015	102	50	2
PB-75A/102M	1302-075000-015	102	65	2½

## PB-1 with oxygen barrier

### For closed circular systems



For closed systems with advanced requirements, we offer PB-1 pipes with an EVOH oxygen barrier. In closed loop systems that are not continually supplied with fresh water containing oxygen, minimization of oxygen ingress through the pipe wall will significantly reduce corrosion risk of metallic components. For this reason the PB-1 barrier pipe has been developed. Dimensions >OD90 have a reduction of a permiation meeting international standards due to the higher wall thickness and the low permiation coefficient of PB-1.



#### Availabilities

##### Coils:

- Pipe diameters medium pipe OD25 – OD75
- Coils of 102m (other lengths on request)

##### Sticks:

- Pipe diameters medium pipe OD25 – OD90
- Sticks of 5,8/12m (depending on diameter)

Flexalen PB-1 pipes with oxygen barrier				
Product code	Product code [NEW]	max. m	DN	Inch
PB-25H/102M	1301-025000-015	102	20	¾
PB-32H/102M	1301-032000-015	102	25	1
PB-40H/102M	1301-040000-015	102	32	1¼
PB-50H/102M	1301-050000-015	102	40	1½
PB-63H/102M	1301-063000-015	102	50	2
PB-75H/102M	1301-075000-015	102	65	2½

# Protectube

## Universal ducting

We've developed this range as a protective solution for channeling ingenuity. This universal robust, yet flexible insulation duct provides future-proof flexibility for any combination of pipes, tubes and cables.

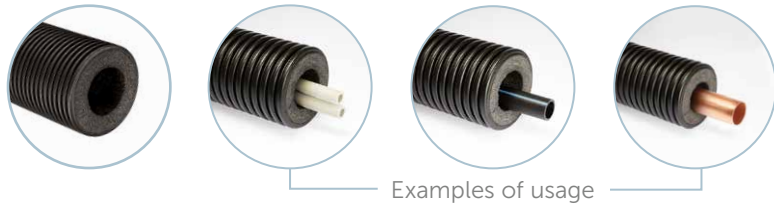

## Harnessing creativity

Protectube acts as a thermal, sound, and mechanical barrier for a wide scope of applications, both indoor and outdoor. It can furnish great creativity of use in an efficient, and sustainable solution. Because of its light weight and flexibility, Protectube can be quickly and easily installed under river crossings, railways or buildings, used as feed lines for heat pumps or split air conditioning, ... the possibilities are endless. And they remain endless, even for future replacement or up-scaling.

## Cover all bases

Just like our other insulated components, Protectube is made from extruded polyolefin foam to a robust HDPE outer casing, offering excellent thermal performance as well as protection against moisture, humidity, frost and mechanical loads. It is equally safe and environmentally friendly in terms of sustainability and recyclability.

 Sustainability

- Fully recyclable

 Health

- Produced without (H)CFC
- Complies to REACH
- Complies to VOC (Volatile Organic Components)

 Installation

- Light weight and flexibility allows easy insertion of pipes and cables.
- Possibility to replace inner pipes and cables at any time.

 Service Temperature

- Wide temperature range
- Minimum -15°C
- Maximum 95°C

 Specifications

- Robust and flexible at the same time.
- Ideal protection for thermal and mechanically sensitive pipes and cables.
- Extruded polyolefine foam with a robust inner / outer casing.
- Especially developed by Thermaflex and fully bonded to the PE outer casing.
- HDPE outer casing, offers superior protection against moisture and mechanical loads.

 Flexibility

- Excellent flexibility
- Bending radius: 12x casing diameter

 Availabilities

**Diameter range:**

- Inner (DI): 18 mm to 115 mm (free space)
- Outer (DA): 40mm to 200mm
- Available in coils to max. 500m (depends on diameter)

## 15. PROTECTUBE



Protectube					
Product code	Product code [NEW]	Outer casing O.D. [mm]	Insulation I.D. [mm]	Length* [m]	Bending radius [m]
FV+ISR40	1100-040000-000	40	18/23	500	0.48
FV+ISR50	1100-050000-000	50	23/28	500	0.60
FV+ISR63	1100-063000-000	63	30/35	500	0.75
FV+ISR75	1100-075000-000	75	38/43	500	0.90
FV+ISR90	1100-090000-000	90	40/45	500	1.08
FV+ISR125	1100-125000-000	125	63/68	300	1.50
FV+ISR160	1100-160000-000	160	90/95	150	1.92
FV+ISR200	1100-200000-000	200	110/115	100	2.40

\*) Longer on request

# Flexalen 1000+

## Timeless multifunctionality

Flexalen 1000+ is our multi-purpose solution for energy distribution and offers a range opportunities for micro-networks. The possible combinations offer flexible freedom today, as well as for future adaptations or additions.

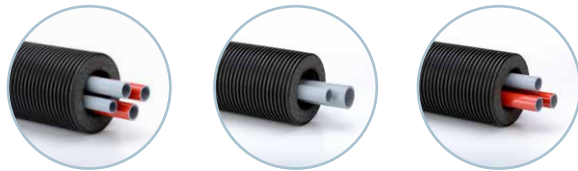

## Flexible freedom

If your ambition is to combine heat and domestic hot water coming from a heat pump, wood chip boiler or solar installation as well as your frost protection and other cables in a single casing, Flexalen 1000+ is the ideal choice. It can combine various applications in a single, homogeneous distribution network to serve the energy supply, and demand of your close by community.

## Clear and simple

This range of our wide Flexalen product family is highly suitable for micro-networks. A variety of connection lines can be combined in a single solution, making it highly over-seeable. The flexibility and homogeneity of the components allow for a quick and easy installation with minimal disturbance to the existing environment.

 Sustainability

- Fully recyclable
- Satisfies the requirements for sustainable construction

 Health

- Produced without (H)CFC
- Complies to REACH
- Complies to VOC (Volatile Organic Components)

 Installation

- Easy to install
- Safe welding connections due to Polybutene pipes
- Assembly on customer specification
- Full compatibility with Flexalen 600

 Pressure rating

- up to OD110 20°C/16bar    ≥ OD125 20°C/10bar
- up to OD110 70°C/10bar    ≥ OD125 70°C/8bar
- up to OD110 95°C/8bar    ≥ OD125 95°C/5bar

 Specifications

- Free moving carrier pipes
- Multi-line capability
- Homogenous connection between outer casing and insulation

 Flexibility

- Excellent flexibility
- Bending radius (depending on inner pipe selection)

 Availabilities

**4 standard medium pipe combinations:**

- OD32/OD25, OD40/OD25, OD 50/OD25, OD63/OD32

**Various combinations of OD16 till OD63 mm pipes possible e.g:**

- H2/32A25A20...2 times OD32 heating, OD25 potable, OD20 circulation

**Various insulation thicknesses possible depending on ID**

- Up to 50 m length in coils available (depends on diameter)
- End caps for water tight sealing between outer casing and medium pipes





Let's roll out a sustainable  
future together



# The Flexalen® system

## The process

Our polybutene pipes (Pb-1) and Thermoplastic Elastomeric (TPE) foam are produced in a low-energy extrusion process (for 95% powered by renewables), compressing the melted plastic. Both the pipe and foam are inherently fit for purpose without modification or secondary processing, with the additional advantage that any off-specification production is recycled within the process.



Flexalen pre-insulation happens on a 100% clean and controlled factory environment, ensuring optimal and sustainable insulation performance of the finished product which is then cooled, and coiled or cut.

Optimization and smart designs offer important added value to a network. We focus on minimizing total cost of ownership and maximizing the speed of implementation. A support program for innovative network design, available to all professional designers/engineers, offers the right solution/tool in combination with Flexalen network concepts.

Our prefabricated house connections reduce the amount of on-site connections by at least 70% compared to traditional systems. This minimizes the number of joints and the risk of leakages so that network lifetime is maximized. The entire network is then tested in-house, to ensure guaranteed network performance.

Due to the flexibility of the material, Flexalen can be easily coiled, allowing a swift roll-out from the coil directly into the trench. The connection lines can then be easily bent to the house connection points and linked to the heating or cooling system.

The houses can then be hooked up to the main network using homogeneous welding techniques or with a plug-and-play solution using Flexalink ready-made connections. That means risk, maintenance and overhead costs are also kept to a minimum.

After final pressure testing, the Flexalen network can enter full operation and secure affordable, and future-proof comfort for its end-users.



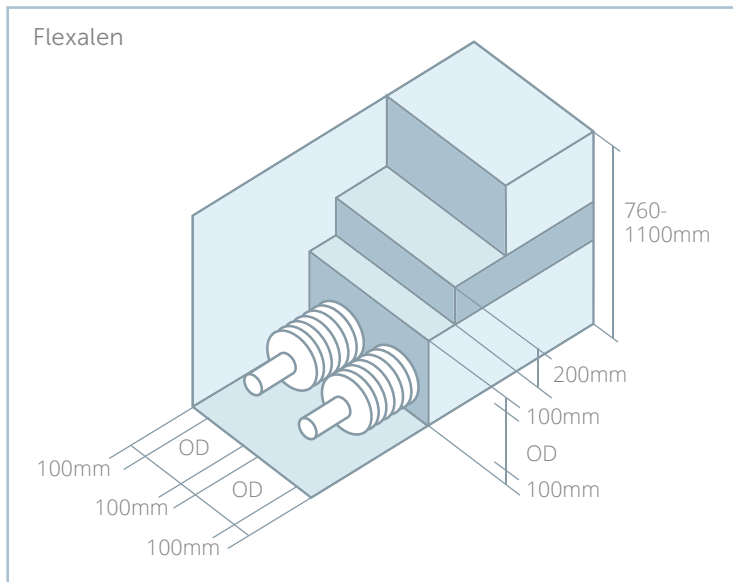
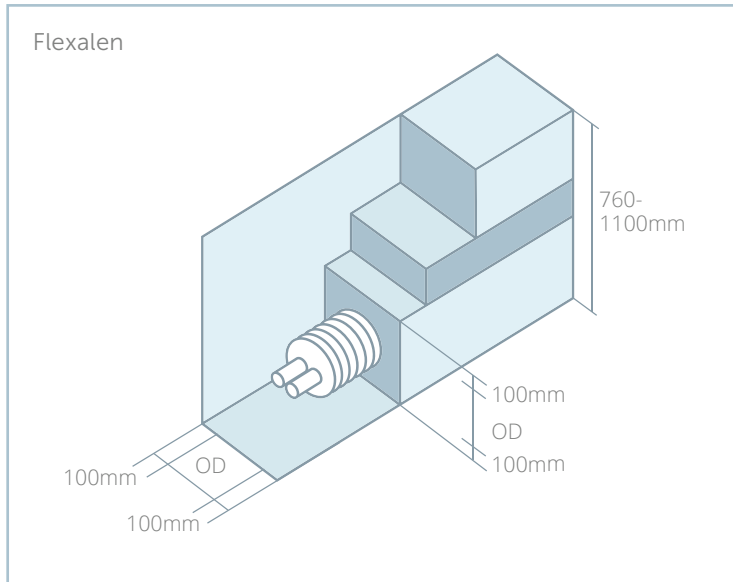

## Trenching Details

### Structure of the pipe trench for long-distance heating pipes

The structure of a long-distance heating pipe is determined by the designer on the basis of the instructions supplied by the pipe manufacturer, the valid standards and the individual circumstances in the building.

A sand bed of at least 100 mm in any direction must surround the pipeline after the sand has been compressed. The size of the grains of sand should not be bigger than 3 mm. There must be no coarse grains. After the back filling, the sand is compressed. Thus some small air holes remain in the sand which are only connected by narrow channels (high flow resistance -no air convection in the sand).

Further back filling is normally undertaken using spoil from the trench. Coarse-grain gravel or road metal with or without a small soil portion are not suitable for the filling as they produce air channels with relatively big cross-sections and thus encourage the convection of the encircled air or the water which has invaded the trench. The filling must have a portion of fine-grained material, which prevents the development of continuous air channels. After the filling has been poured in, it must be compressed to produce a compact packing of the material.

The covering depends on the location of the ditch. In roads it is formed by the building profile of the road, in meadows and fields it is formed by a „humus layer“. In no case may the filling reach the surface. A clear layering of the materials represents an additional barrier for the heat transportation in transitional areas between the different layers.

The ditch must be prepared in accordance with the pictures on the left. For those areas that must bear transport loads, the law provides a minimum cover of 0.8 m (load class SLW 60); in areas without transport the regulations demand a minimum cover of 0.5m. Please consider the corresponding standards and regulations regarding the pipeline course of long-distance heating pipes. During construction, the trench must be kept dry. For very damp soil, drainage of the trench is recommended to improve the heat insulation effect of the distribution network.

## Electrofusion welding

### Automize to optimize

The quality level of joints is critical to the performance and lifespan of the network. So they should be as accurate and reliable as possible. Electrofusion welding is the automated technology developed to meet exactly these expectations, and making welded connections child's play

### User-friendly, system-friendly

Electrofusion is a highly efficient welding technology that combines special fittings with built-in electric heating elements to ensure complete homogeneity of the system. The welding machine connects to the fitting, and automatically determines the welding time, before left to cool. This process is highly suitable for joints made on site or in tight areas.

### Durable simplicity

This automated welding process makes pipe joining much easier, faster and it minimizes 'human' errors. As the weld is made on the outside of the tube, the inside remains smooth, contributing to the flow quality of the entire network, and preventing scale and incrustation that normally causes serious problems at joints.



Electrofusion Socket Connection



Electrofusion Couplers



Electrofusion Couplers (BIG)



Electrofusion T-pieces



Electrofusion Elbows



Electrofusion Reducers



Electrofusion Endcaps



Electrofusion Valves

## Electrofusion connections



**Coupler**  
d: 16 - 110



**Elbow 90°**  
D1: 16 - 110



**Special Reducer With Adaptor**  
D1: 75 - 110  
D2: 16 - 50



**Coupler (BIG)**  
d: 125 - 225



**Elbow 45°**  
D1: 16 - 110



**Endcap**  
D1: 16 - 63



**T-Piece 90° Equal**  
D1: 16 - 110



**Elbow 90° Socket Spigot**  
d: 16 - 63



**Valve**  
D1: 20 - 63  
D: 70 - 90



**T-Piece 90° Branch Off Pipe Reduction**  
D1: 20 - 63  
D2: 16 - 40  
D3: 20 - 63



**Elbow 45° Socket Spigot**  
D1: 16 - 63



**Valve With Spigot For Drain**  
D1: 20 - 63  
D: 70 - 90



**T-Piece 90° Connection Pipe Reduction**  
D1: 20 - 32  
D2: 16 - 25  
D3: 16 - 25



**Reduction**  
D1: 20 - 110  
D2: 16 - 90



## Polyfusion welding

### The basic solution

Polyfusion welding technology offers a simple and cost-effective solution for homogenizing your distribution system, ideal for indoor connections.

### Steady performance

Homogenous connections are a fundamental aspect of implementing energy-efficient distribution solutions. The hot-melt possibility of polybutene offers easy connections with high cohesive strength to ensure an optimal performance of the system. That homogeneity can only be achieved with the right tools and the right techniques.

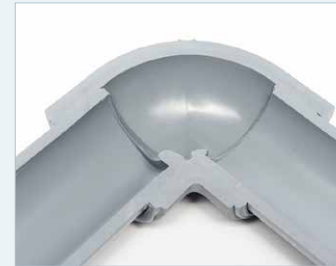

Polyfusion Socket Welding



Polyfusion T-pieces



Polyfusion Elbows



Polyfusion Reducers

## Polyfusion connections



**Coupler**

d: 16 - 110  
D2: 22 - 133



**Elbow 90°**

d: 16 - 110  
D2: 22 - 132



**Reduction**

D1: 20 - 110  
d: 16 - 90

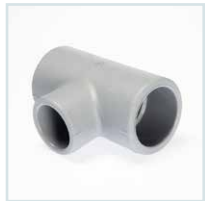

**T-Piece 90° Equal**

d: 16 - 110  
D2: 22 - 133



**Elbow 45°**

d: 16 - 110  
D2: 22 - 134



**Endcap**

D1: 16 - 63

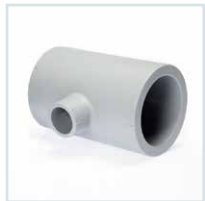

**T-Piece 90° Branch Off Pipe Reduction**

d: 20 - 63  
d2: 16 - 25  
d3: 20 - 63



**Elbow 90° Socket Spigot**

d: 16 - 63  
D2: 22 - 81



**Valve**

d: 20 - 63  
D2: 70 - 90

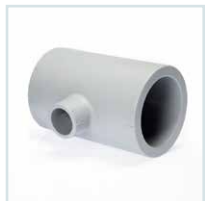

**T-Piece 90° Connection Pipe Reduction**

d1: 20 - 25  
d2: 16 - 25  
d3: 16 - 20



**Elbow 45° Socket Spigot**

d: 16 - 63  
D2: 22 - 81



**Valve With Spigot For Drain**

d: 20 - 63  
D2: 70 - 90

## Butt fusion welding

### When the size counts

Butt-fusion welding offers a safe and proven solution for homogeneous connection of larger diameters. We recommend Butt-fusion for diameters starting with OD 110.

### Standard equipment can be used

Most Butt-fusion machines, used for PE or PP pressure pipes can be used with Flexalen PB pipes as well. The welding parameters have to be adjusted to the needs of PB. Our experts and instructions will support you with applying this technology most effectively.

## Butt fusion connections



**T-Piece 90° Equal**

d: 125 - 225



**Elbow 90°**

d: 125 - 225



**Reducer**

d1: 125 - 225

d2: 110 - 160



**Elbow 45°**

d: 125 - 225



Butt fusion connection



Butt fusion Elbows



Butt fusion T-Pieces



Butt fusion reducer

## Tools & Accessories

### Solidifying your solution

Our custom selection of tools and accessories is dedicated to secure all-rounded, and optimally sustainable solutions. With the right equipment, a fully integrated Flexalen system can be installed swiftly, and soundly. An integral solution is impossible without the right means to implement it. That's why we've attuned our equipment perfectly to our pre-insulated piping solutions – both in terms of quality and handling.

### Maximum performance, minimum hassle

That consistency starts with a completely homogeneous system. Our complete range of PB-1 fittings and modern welding technologies can ensure that homogeneity and water-tight sealing of all indoor and outdoor installations. That way, the performance of the system can be maximised at full speed, and no hassle.

### All-in solutions

We also accommodate transition to other materials such as mechanical fittings by compression, flanges or weld-to-weld solutions. All Thermaflex components are carefully selected and tested to fulfil technical specifications as well as sustainability standards to the highest degree.



Tools



Transitions



Flange Connections



End Caps



Restraining Clamps



Insulation Kits



Annular Space Sealings



Spare Parts (On Request)

# Tools



Pipe Cutter



Timer



Tangit KS  
Cleaning Tissue



Scraper Set

D1: 16 - 25  
D2: 25 - 90



Chamfering  
Tool



Gloves



KS Tangit  
Cleaner

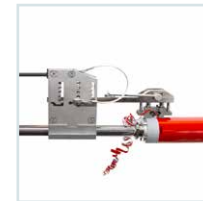

Scraper



Hand Scraper



Cable Cutters



Tissues



Manual pipe  
peeling and  
Chamfering  
Tool

D1: 20 - 110



Temperature  
Stick



Align Clamp

D1: 25 - 40  
D2: 63 - 110



Roller Support



Thermometer



## 20. TOOLS & ACCESSORIES



**Electrofusion Machine**

D1: 125  
D2: 160  
D3: 225



**Polyfusion Welding Handmachine SET**

D1: 16  
D2: 63 - 110



**Buttfusion Machine CNC**



**Electrofusion Machine**



**Polyfusion Welding Handmachine Complete SET**

D1: 16  
D2: 63



**Buttfusion Machine ECO**



**Polyfusion Welding Machine**

D1: 20  
D2: 125



**Heatbushes For Polyfusion Welding (Hand) Machines**

D1: 16 - 110



**Reduction Clamp**

D1: 110 - 225



**Rotation Scraper**

D1: 125 - 225



**Clamp for Buttfusion Machine**

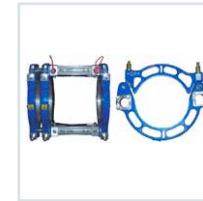

**Outer Clamp**

For spare parts and further support  
[nederland@thermaflex.com](mailto:nederland@thermaflex.com)

## Transitions



**Electrofusion Adaptor Union Male Thread**

d: 16 - 63  
D2: 41 - 110



**Spigot Adaptor Union Male Thread**

d: 16 - 63  
D2: 41 - 104



**Adaptor Union Socket Male Thread**

d: 16 - 63



**Electrofusion Adaptor Union Female Thread**

d: 16 - 63  
D2: 41 - 110



**Spigot Adaptor Union Female Thread**

d: 16 - 63  
D2: 41 - 104



**Adaptor Union Socket Female Thread**

d: 16 - 63



**Spigot With Adaptor Male Thread**

d: 16 - 63



**PB-Steel Transition**

d: 25 - 125  
D: 3/4' - 4ft



**BCA Compression Fitting**

D1: 16 - 110  
D2: 1/2" - 4ft



**Spigot With Adaptor Female Thread**

d: 16 - 63



**PB-Copper Transition**

D1: 20 - 63  
D2: 1/2" - 2ft



**Combigrrip**

d: 50 - 110  
D: 1 1/2" - 4ft

Article	BCA Compression fitting	PB-Steel Transition	PB-Copper Transition	Adaptor Union Socket	Spigot Adaptor
<b>Article Code</b>	BCA-PB	RND-TF-PB	RND-TF-PB	PB-HV / GF-HV	GF-TFP
Dimensions	O.D. 16 - 110	O.D. 25 - 125	O.D. 25 - 125	O.D. 16 - 63	O.D. 25 - 63
Transitions	male thread	Steel spigot	Steel spigot	male and/or female thread	male thread
Underground laying	no*	yes	yes	no*	no*
Assembly	Easy fitting without any special tools	Polyfusion- or Electrofusion welding	Polyfusion- or Electrofusion welding	Polyfusion- or Electrofusion welding	Polyfusion- or Electrofusion welding

\*) not primarily recommended

# Flanges



**Electrofusion Flange Adaptor Flat**

**D1:** 34 - 150 **d:** 20 - 110  
**D2:** 27 - 131 **DN:** 15 - 100



**Polyfusion Flange Adaptor Flat**

**D1:** 34 - 150 **d:** 20 - 110  
**D2:** 27 - 131 **DN:** 10 - 100



**Buttfusion Flange Adaptor Flat**

**D1:** 132 - 235 **d:** 125 - 225  
**D2:** 162 - 274 **DN:** 150 - 200



**Electrofusion Flange Adaptor With Groove**

**D1:** 34 - 150 **d:** 20 - 110  
**D2:** 27 - 131 **DN:** 15 - 100



**Polyfusion Flange Adaptor With Groove**

**D1:** 29 - 150 **d:** 16 - 110  
**D2:** 27 - 131 **DN:** 15 - 100



**Buttfusion Backing Flange**

**D:** 226 - 350 **D3:** 18 - 22  
**D1:** 180 - 295 **DN:** 100 - 200  
**D2:** 125 - 225



**Backing Flange**

**D:** 106 - 226 **D2:** 20 - 110  
**D1:** 65 - 180 **D3:** 14 - 18



**Flange Gasket For Flange Adaptor**

**D:** 51 - 162 **DN:** 15 - 100  
**D1:** 20 - 110



**Flange Gasket For Buttfusion Flange Adaptor**

**D:** 162 - 273 **DN:** 100 - 200  
**D1:** 125 - 225

Measurements of flange connections												
Pipe diameter d [mm]	20	25	32	40	50	63	75	90	110	125	160	225
Numbers of drilling	4	4	4	4	4	4	4	8	8	8	8	8
Bolts (not included)	M12x70	M12x75	M12x75	M12x80	M12x85	M16x85	M16x90	M16x90	M16x95	M16x130	M20x140	M20x160
D [mm]	106	118	122	142	156	171	191	206	226	226	296	350
D1 [mm]	65	75	85	100	110	125	145	160	180	180	240	295
D2 [mm]	28	34	42	51	62	78	92	110	133	135	178	238
D3 [mm]	14	14	14	18	18	18	18	18	18	18	22	22
H [mm]	18	18	17	17	19	20	21	21	22	23	28	31
Torque [mm]	10	15	15	20	25	35	40	40	50	50	60	75

O.D. 20 - 110 mm

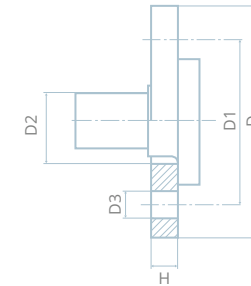

O.D. 125 - 225 mm

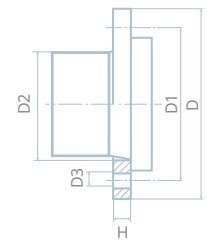

# End Caps



End caps for single pipe system					
Product code	Product code [NEW]	Carrier pipe O.D. [mm]	Carrier pipe O.D. [mm]		Weight [kg]
VS-MAN40A20-A16	1741-040020-016	40	16, 20		0.025
VS-MAN50A25-A20	1741-040025-020	50	20, 25		0.029
VS-MAN63A32-A16	1741-040032-016	63	16, 20, 25, 32		0.043
VS-MAN75A40-A16	1741-040040-016	75	16, 20, 25, 32, 40		0.075
VS-MAN90A50-A20	1741-040050-020	90	20, 25, 32, 40, 50		0.095
VS-MAN125A75-A32	1741-040075-032	125	32, 40, 50, 63, 75		0.180
VS-MAN160A90-A50	1741-160090-050	160	50, 63, 75, 90		0.220
VS-MAN200A125-A110	1741-200125-110	200	110, 125		0.225



End caps for double pipe system					
VS-MAN63A2/20-A2/16	1742-063020-016	63	16, 20		0.045
VS-MAN75A2/20-A2/16	1742-075020-016	75	16, 20		0.055
VS-MAN90A2/25-A2/16	1742-090025-016	90	16, 20, 25		0.080
VS-MAN125A2/32-A2/20	1742-125032-020	125	20, 25, 32		0.185
VS-MAN160A2/50-A2/32	1742-160050-032	160	32, 40, 50		0.205
VS-MAN200A2/63	1742-200063-063	200	63		0.225



End caps for multi pipe systems							
Product code	Product code [NEW]	Carrier pipe O.D. [mm]	Outlet 1	Outlet 2	Outlet 3	Outlet 4	Weight [kg]
FV+MAN160ML	1744-160000-000	160	25, 32, 40	20, 25, 32	20, 25	20, 25	0.22
FV+MAN200ML	1744-200000-000	200	32, 40, 50, 63	25, 32, 40	25, 32, 40	20, 25, 32	0.40



End caps Flexalen SL Straight Lengths		
Product code	Product code [NEW]	Description
FV-MAN160FL	1745-160160-000	End caps to make the sealing between medium pipes and smooth casing pipe.
FV-MAN225FL	1745-225225-000	

## Insulation Kits



### Shrink Sleeves

D1: 63 - 315

D2: 40 - 315



### Insulation End Cap Set

D1: 90 - 315



### Flexalen Foam Insulation Reduction Couplers

D1: 125 - 200

D2: 90 - 160



### Flexalen Foam Insulation Couplers

D1: 40 - 200

D2: 40 - 200



### Flexalen Pur Insulation Couplers

D1: 225 - 315

Insulation kit								
Product code	Product code [NEW]	Casing pipe O.D. [mm]	Sliding muff				Insulation	Weight [kg/m]
			O.D. [mm]	Wall thickness [mm]	Shrinkable	length* [mm]		
FV-UM40PO	1746-040040-000	40	~69	3	no	600	~ ø 30mm x 13mm	0,52
FV-UM63-50PO	1746-063050-000	50, 63	~84	3	no	600	~ ø 50mm x 13mm	0,74
FV-UM90-75PO	1746-090075-000	75, 90	~103	3	yes	700	~ ø 76mm x 13mm	1,02
FV-UM125PO	1746-125125-000	125	~140	3	yes	700	~ ø 108mm x 13mm	1,34
FV-UM160PO	1746-160160-000	160	~177	3	yes	700	~700x600mm x 20mm	1,78
FV-UM200PO	1746-200200-000	200	~218	3,5	yes	700	~700x1000mm x 20mm	2,80
FV-UM225PO	1746-200225-000	225	~245	4	Yes	700	2k-Pur	3,30
FV-UM250PO	1746-200250-000	250	~296	4,5	Yes	700	2k-Pur	3,50
FV-UM315PO	1746-200315-000	315	~345	5	Yes	700	2k-Pur	4,50

# Restraining Clamps

## Lock-in for stable welding

We offer restraining clamps that feature a double clamp with anchor plates, as well as threaded pipes and elbows to restrain the pipes where necessary. The elasticity of the material allows the total pipe system to self-compensate, eliminating the need for expansion loops or bellows. Restraining clamps are only necessary at the end of the pipeline at the building entry, effectively avoiding excess stress on the transition fittings.

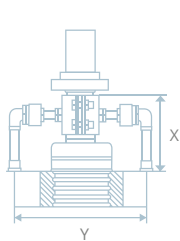

Restraining Clamps for single pipe system  
O.D.16 - O.D.50,  
O.D. 160 - O.D.225

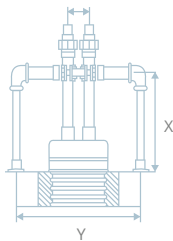

Restraining Clamps for pipe systems  
O.D.16 - O.D. 63

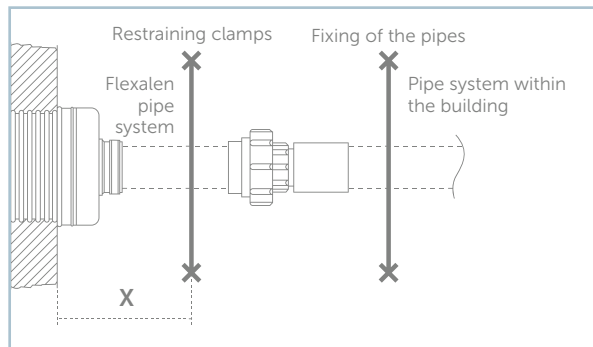

### External pipelines, internal pipelines – horizontal

For above ground horizontal lines, we recommend that all coiled Flexalen pipelines are supported by angled bar support systems or cable trays with strong clips/ties placed every metre along the entire length. The Flexalen anchoring system must be used with transition ends. (see sketch)

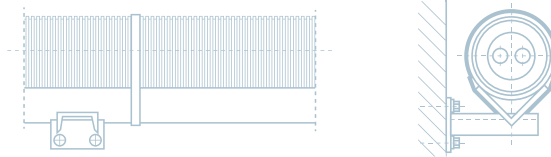

### External pipelines, internal pipelines – vertical

For vertical lines, we recommend that the pipeline is secured to the wall or cable tray to the casing pipe at every metre. The PB pipe in the Flexalen pipe system should be anchored every 4 to 5 metres (in most cases on each floor). Suitable restraining clamps should be used on both sides of the clamp.

### Non insulated Polybutene pipelines

Precautions must be taken for expansion and contraction as well as for pipe support when using an un-insulated PB. Bare PB pipes require complete and permanent protection from ultraviolet (UV) radiation. The layout of in-house pipeworks significantly depends on the area (visible or non-visible) where the PB pipe system is to be installed, also depending on local standardization.

Elongation forces of PB pipes

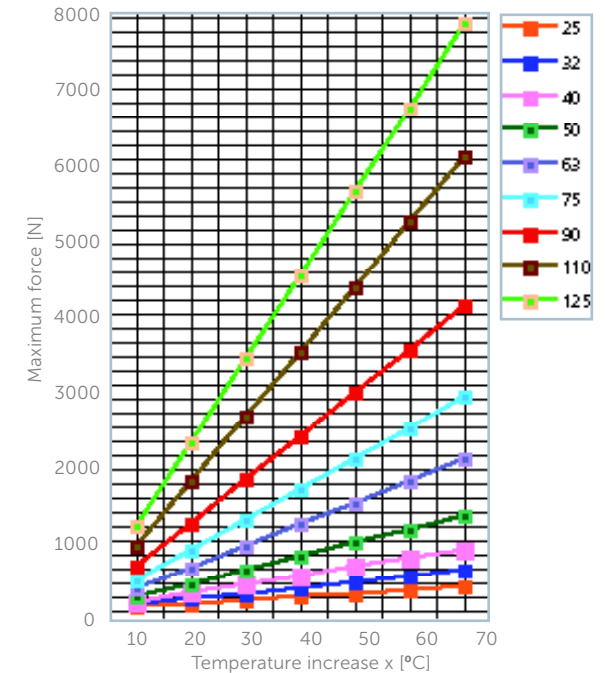

Carrier pipe O.D. [mm]	X *) [mm]	max. elongation force per pipe **) [kN]
25	~ 180	0.35
32	~ 180	0.60
40	~ 180	0.90
50	~ 180	1.40
63	~ 180	2.20
75	~ 180	3.00
90	~ 180	4.30
110	~ 180	6.50
125	~ 180	8.30

\*) depending on mounting situation

\*\*) temperature difference dT = 70K

## 20. TOOLS & ACCESSORIES



Restraining Clamp for single pipe systems						
Product code	Product code [NEW]	Carrier pipe O.D. [mm]	Weight [kg]	Measurements		
				X [mm]	Y [mm]	Z [mm]
F-RCLAMP16	1791-016016-001	16	1,34	~175	~278	x
F-RCLAMP20-25	1791-025020-001	20, 25	1,36	~175	~278/~283	x
F-RCLAMP32	1791-032032-001	32	1,36	~175	~290	x
F-RCLAMP40	1791-040040-001	40	1,40	~175	~303	x
F-RCLAMP50	1791-050050-001	50	1,40	~175	~307	x
F-RCLAMP63	1791-063063-001	63	6,10	~175	~420 - 475	x
F-RCLAMP75	1791-075075-001	75	6,50	~175	~435 - 485	x
F-RCLAMP90	1791-090090-001	90	7,00	~175	~455 - 515	x
F-RCLAMP110	1791-110110-001	110	7,60	~175	~485 - 540	x
F-RCLAMP125	1791-125125-001	125	8,00	~175	~485 - 540	x
F-RCLAMP160	1791-160160-001	160	2,26	~175	~435	x
F-RCLAMP225	1791-225225-001	225	2,36	~175	~505	x



Restraining Clamp for double pipe systems						
Product code	Product code [NEW]	Carrier pipe O.D. [mm]	Weight [kg]	Measurements		
				X [mm]	Y [mm]	Z [mm]
F-RCLAMP2/16	1791-016016-002	16	1,41	~175	~326	~48
F-RCLAMP2/20-25	1791-025020-002	20, 25	1,46	~175	~330/~335	~50/~52
F-RCLAMP2/32	1791-032032-002	32	1,50	~175	~345	~55
F-RCLAMP2/40	1791-040040-002	40	1,54	~175	~360	~57
F-RCLAMP2/50	1791-050050-002	50	1,56	~175	~375	~68
F-RCLAMP2/63	1791-063063-002	63	1,68	~175	~410	~78



## Wall entry for corrugated casing pipes

### Optimized flow with sealed wall penetrations



#### Suitable for ground water pressure up to 0,5 bar for corrugated outer casings and 3 bar for smooth outer casings / no contamination

- Pressure-tight annular sealing between all Flexalen pipe systems and core drilled holes / scabbard tubes for wall openings
- Suitable for high ground water tables
- Oil, fuel and solvent-resistant, temperature and fire-resistant designs available
- Protected location in masonry
- Stainless steel bolts
- Absorption of impact, noise and vibration loads
- Cathodic pipe



#### Annular space sealant for demanding situations

- Robust rubber parts guarantee long lifetime
- Suitable for high ground water tables (only for F-SL with smooth outer casing)
- Oil, fuel and solvent-resistant, temperature and fire-resistant designs available
- Protected location in masonry
- Also perfectly suited for retrofitting
- Easy and rapid installation with prefabricated connections
- Galvanized or stainless steel bolts upon request
- Absorption of impact, noise and vibration loads
- Cathodic pipe
- Suitable for ground water without pressure

The corrugated construction of Flexalen 600 pipe casing in combination with quicksetting sealing cement offers a water-tight seal between the entry hole and the Flexalen casing. This means that there is no need for extra rubber-based wall entry seals when using Flexalen 600 coiled pipes.

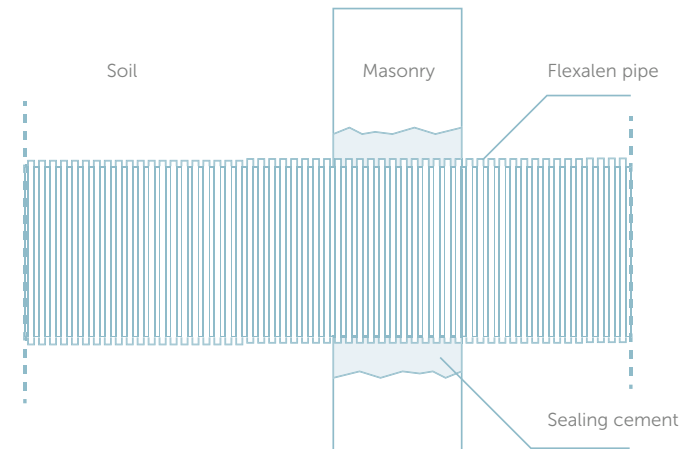

## 20. TOOLS & ACCESSORIES



Annular Space Sealing Professional				
Product code	Product code [NEW]	Carrier pipe O.D. [mm]	Core drilling [mm]	Description
FV-WB040B100	1760-040100-000	40	100	Wall entry for jacket pipe/medium pipe at core drilling. Suitable for ground water pressure up to 0,5 bar.
FV-WB050B100	1760-050100-000	50	100	
FV-WB063B125	1760-063125-000	63	125	
FV-WB075B125	1760-075125-000	75	125	
FV-WB090B150	1760-090150-000	90	150	
FV-WB125B200	1760-125200-000	125	200	
FV-WB160B250	1760-160250-000	160	250	
FV-WB200B300	1760-200300-000	200	300	
FV-WB225B300	1760-225350-000	225	350	
FV-WB315B400	1760-315400-000	315	400	



Annular Space Sealing Not Watertight				
Product code	Product code [NEW]	Carrier pipe O.D. [mm]	Core drilling [mm]	Description
FV-MD90KB	1761-090000-000	90	120	Wall entry for jacket pipe/medium pipe at core drilling. Suitable for ground water non-pressure.
FV-MD125KB	1761-125000-000	125	150	
FV-MD160KB	1761-160000-000	160	200	
FV-MD200KB	1761-200000-000	200	250	
FV-MD225KB	1761-225000-000	225	x	
FV-MD250KB	1761-250000-000	250	300	
FV-MD315KB	1761-315000-000	315	400	

## 21. CASE STUDIES



### Westin Playa Bonita in Panama



#### STATISTICS

620 rooms on 23 floors including 6 auditoriums and 4 restaurants supplied with sustainable cooling and heating, chilled and hot potable water  
0 incidents recorded since project completion

### Purmerend, Netherlands



#### STATISTICS

4,000 homes reconnected  
50,000 tons of CO<sub>2</sub> saved  
84% cut in unplanned maintenance  
50% cut in water supply  
10% cut in heat loss  
33 steady jobs created

### Edine, Turkey



#### STATISTICS

34% savings on investment achieved with optimized network design to tackle -20 'uncomfortable' degrees temperatures in winter  
3 reliable heating zones installed in only 2 days what results in 12% yearly total savings

### Wörgl in Austria



#### STATISTICS

20 low-energy row houses  
78% installation cost reduction  
176 man hours saved  
100% secure heating & sanitary water supply  
4,500 tons of CO<sub>2</sub> saved per year which is the equivalent absorbed by 225,000 trees

# Purmerend's network resurrection

📍 Purmerend, Netherlands

## District Heating 2.0

The district-heating network in Purmerend is situated in an area with a high ground water level, so the old steel pipes of the district heating network suffered heavily from the corrosion that resulted from this, and its damage to the insulation. This emphasized the need to switch to plastic pipes. Purmerend also wanted to make the district heating network sustainable, yet economical. They wanted to be prepared for the future, when they would like to use biomass and geothermal energy for heating purposes. Their major problem: connections located in difficult crawling spaces underneath the houses where Dutch legislation does not even allow for steel welding.

### Goals

A fast renovation was needed to keep the downtime of the heating/hot water supply short. Speed and space conditions were crucial to keep the disturbances to a minimum for the local government and the residents of Purmerend. The existing district heating network in Purmerend failed to meet the performance demands, so the focus was laid on improving heat loss and securing a full-proof and hassle-free district heating network.

### Main advantages for SVP:

- Joint development of a renovation concept avoiding open flame connections in the crawl spaces
- Development of a high-speed installation concept
- Tailor-made Flexalink for quick, easy, and secure house connections
- Installation trainings and on-site supervision for HAK (pipe installers)
- Project preparation (material lists, network design, logistics)
- Pre-fabricated and customized supply of materials

For a detailed overview of all our case studies, go to [www.thermaflex.com](http://www.thermaflex.com)

### Results

An exceptionally fast connection of about 4,000 houses meant there was very little disturbance for the local residents. Initially, they had been particularly sceptical due to the earlier issues with the network, but ultimately they were positive and grateful of the renovation project once the results became clear.

Precise pre-fabrication per section made it particularly easy for the installer to plan the implementation and reduce time and space requirements. Complaints quickly dropped and the maintenance scheme of the network drastically changed, as maintenance was minimized.







## Our process

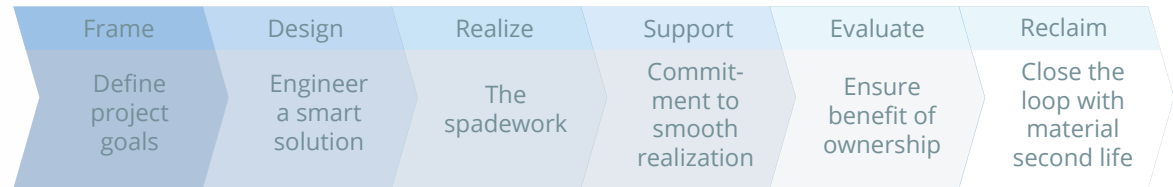

### A customized approach

No two projects are the same. But after seeing thousands of them around the world, we know what makes them a sustainable success. Your specific projects goals come first and act as the 'yardstick' throughout the project. Our very best engineers design the best possible solution and calculate optimal routing and dimensioning; fast implementation and lifecycle performance are always on the top of their minds. Once full alignment on all aspects of the project is reached, it's time for implementation.

Our tools, training and on-site support ensure a smooth implementation of the project. We are only happy when you are. All that's left for users and owners is to enjoy affordable and headache-free comfort for generations to come. After that, safe and efficient reclaim secures the renewed purpose of our carefully selected materials.

### Your very own thermal energy expert

Team up today with our highly dynamic, and professional team of experts and engineers. Our solutions have proven successful in any climate, situation or working conditions. Locally, our teams of professionals across the globe are ready to cater for your needs, from Panama to Siberia.

## What goals do you want to achieve?

- ✓ Cost control
- ✓ Operational efficiency
- ✓ Installation ease and speed
- ✓ Energy saving
- ✓ Environmental capital
- ✓ Life expectancy

CALL US





**THERMAFLEX INTERNATIONAL**

Thermaflex International Holding b.v.  
Veerweg 1, 5145 NS Waalwijk  
[www.thermaflex.com](http://www.thermaflex.com)

 The Netherlands

+31 416 567 777  
[international@thermaflex.com](mailto:international@thermaflex.com)

Follow us on:





[WWW.THERMAFLEX.COM](http://WWW.THERMAFLEX.COM)

Thermaflex International Holding b.v.  
Veerweg 1, 5145 NS Waalwijk  
The Netherlands